

Resistance Measurement Material Testing

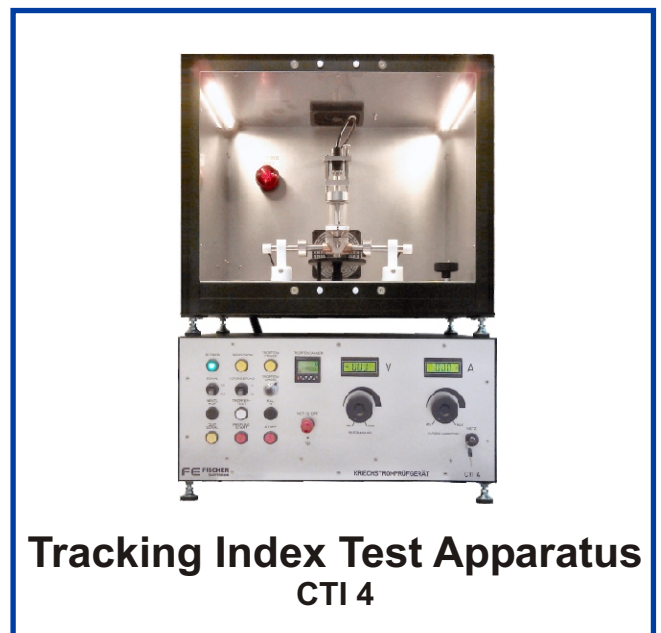
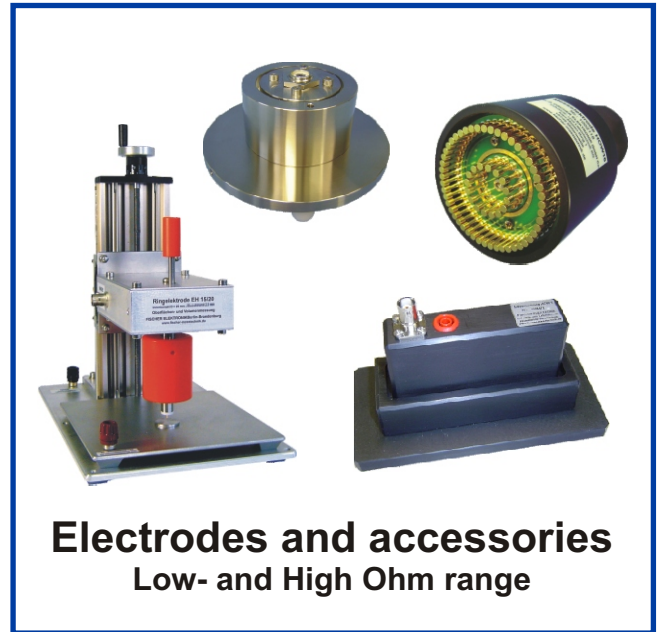

We advise you qualified and individual

Ohmmeters

With the Milli-TO 3 there was developed an ohmmeter, which covers the technical resistance range.

For example the Milli-TO 3 is used for the measurement of small contact resistances with a resolution of $10^{-5} \Omega$ or insulation resistances measured according to preset rugged test voltages from 1 to 500 V.

The integrated current measurement controls the course of charges and discharges of the specimen at High Ohm measurements.

Furthermore, leakage currents of specimens and components between 0.1 pA (10^{-13} A) resolution and 1.1 mA (10^{-3} A) can be measured by the current measurement.

To handle the Milli-TO 3 you can choose between an internal menu or a PC-GUI.

The display shows the values and settings in academic form.

During the selection of the test voltage you can choose between 3 fixed values (10 V, 100 V und 500 V) plus a variable voltage. The test voltage has a low ripple and in case of a short-circuit a very small saved impulse energy.

The short-circuit current is circa 3mA

All functions can be adjusted and controlled from PC level.

Thus a remote-control of the device is possible. The analysis of the values can be handled on the PC.

General Data

Measuring:	control via START-/STOP-button, remote or internal timer
Reading rate:	approx. 1 reading per second within same range
Ranges:	7 ranges, auto ranging or manual ranging
Function:	controlled by buttons, RS232 interface or remote at rear side
Response time:	to rated accuracy 10 minutes
Displays:	2 LCD's with 2 rows by 20 digits each range display in scientific form (e.g. 16.55 E9 for 16.55 G Ω) LED's to indicate V_M ON and FAULT, LED's in all buttons
Indications:	limit indication by relay contact (max. 24 V/ 0.5 A) and beeper for overrun or underrun of programmable limit window; overflow or underflow indicated in display as OVERRANGE or UNDERRANGE and send via RS 232
Connectors:	at the rear side for LIMIT and Remote via SUB-D 9 pole as well as GND and earth pole via 4 mm panel jack
Safety class:	Schutzklasse 1 (Germany)
Protective System:	Schutzart IP 40 (Germany)
Temperature:	operating: 15 °C - 23 °C - 35 °C storage: -10 °C to +60 °C
Humidity:	max. 50 %, no condensation allowed!
Housing:	desktop case with metal hand grip
Size in mm:	W/H/D 340 x 150 x 300

Measurement methods

Low Ohm Range

The Low Resistance range extends to 7 measuring ranges up to 180 k Ω . The resolution in the most sensitive range is 10 $\mu\Omega$. The DC test voltage at the specimen reaches 180 mV at 1800 Digit. If you choose the wrong measuring range, the test voltage is limited to 4 V. The maximum measuring current in the lowest resistance range is 1 A. Low-resistance test objects are measured in four-pole technology (four-wire measuring principle according to Kelvin) to hide the measuring line resistances, in which the voltage drop occurring on the test object is fed to the sense terminals via separate lines.

Specimens for which the test lead resistance is negligible can also be measured very well using two-pole technology.

High Ohm Range

The High Ohm range captures resistances from 1 k Ω to 1.6 P Ω in 8 measuring ranges. High and low-resistance range therefore overlap well. The measuring voltage source for the three preselectable measuring voltages 10 V, 100 V and 500 V has exceptionally good properties. The ripple is very small. As a result, the true insulation resistance of capacitive test objects, especially capacitors, foils or other thin samples, can be easily measured without falsification due to constant charging and discharging processes. The short-circuit current of the measuring voltages is limited to approx. 3 mA for safe working. Since the stabilization takes place purely electronically without smoothing capacitors at the measuring voltage output, no current spike occurs in the event of a short circuit.

Milli- and TeraOhmmeter Milli-TO 3



High-Ohm (High resistance measurement)

Measuring range:

at test voltage	1 V: 0.9×10^3 to $3.3 \times 10^{12} \Omega$
	10 V: 9×10^3 to $33 \times 10^{12} \Omega$
	100 V: 90×10^3 to $0.33 \times 10^{15} \Omega$
	500 V: 450×10^3 to $1.6 \times 10^{15} \Omega$
	up to 2×10^{15} detectable through current measurement

Accuracy at 23 °C +/- 1 K within 12 months:

range 1 to 5:	+/- 0.3% +2 digits
range 6:	+/- 0.5% +2 digits
range 7:	+/- 1% +2 digits

Temperature coefficient:: 15 °C to 35 °C: +/-0.1% / K

Test voltage: 10 V, 100 V, 500 V or variable 1 V bis 500 V

Accuracy of test voltage: at 23 °C: +/- 0.2 %

Temperature coefficient of test voltage: +/- 0.01 % / K

Temperature coefficient

of test voltage: +/- 0.01 % / K

Test voltage source: permanently short-circuit proof

Overvoltage protection at:

V_M 10 V:	20 VDC
V_M 100 V:	200 VDC
V_M 500 V:	750 VDC
var. V_M 1 V to 500 V:	$2 \times V_M$, max. 750 VDC

Test Voltage V_M OFF: EUT discharge over 10 k Ω (the contact V_M is connected to GND through a 10 k Ω resistor)

Overvoltage at V_M OFF: +/- 100 VDC

R_X / I_X connectors: coax jack 4 mm/13 mm (DIN 47284)

V_M / GND: panel jack 4 mm

Special version: Milli-TO 3 cable

For measurements at one-sided grounded specimens (e.g. the Measurement of volume resistance of layed floors or measurements in the water quench) or using a battery-supplied reference potential, the special version of our Milli-TO3, the **Milli-TO 3 cable** is available for you.

Low-Ohm (Low resistance measurement)

Measuring range:	180 m Ω to 180 k Ω
Resolution at 4½-digit display:	range 1: 10 $\mu\Omega$ range 7: 10 Ω
Method of measuring:	2- or 4-pole method Kelvin method) decade constant current
Compensation and controlling of thermo-voltage:	0 to +/- 20 mV allowed
Accuracy at 23 °C +/- 1K:	+/- 0.2 % of input +/- 2 digit (typically 0.1 %)
Temperature coefficient (15 to 30 °C):	+/- 0.1 % / K
Max. voltage over EUT:	< 4 VDC
Max. external voltage between source clamps:	-24 VDC and +3 VDC
Max. external voltage between sense clamps:	+/- 48 VDC
R_X connectors:	4 x 4 mm socket or 5-pol DIN connector
Fuse in the low-ohm circuit:	1.6 AMT (at the rear side)

I_X (Current measurement)

Measuring range:	0.01×10^{-12} A
resolution	to 1.1×10^{-3} A
Display:	3½ digit (0.0 to 1.100)
Accuracy at 23 °C +/- 1 K:	
range 1 to 5:	+/- 0.2 % +2 digit
range 6:	+/- 0.5 % +2 digit
range 7:	+/- 1 % +2 digit
Temperature coefficient (15 to 35 °C):	+/- 0.02 % / K
Internal resistance of the circuit (R_i):	
range 1:	200 Ω (auto) and 1.1 k Ω
range 2:	10.1 k Ω
range 3:	100 k Ω
range 4:	1 M Ω
range 5:	10 M Ω
range 6:	100 M Ω
range 7:	1 G Ω
Overvoltage protection at input R_X / I_X :	+/- 10 VDC
Overcurrent protection at input R_X / I_X :	+/- 10 mADC

TeraOhmmeter TO 3



Application

The TO 3 precision resistance measuring device is a further development of the Milli-TO 2, which has been manufactured and sold with great success for more than 30 years.

With the TO 3, resistances from 1 kOhm to 1.6 PetaOhm can be measured easily and reliably and the smallest sample currents can be detected with the current measurement.

When operating and programming the device, you can choose between internal menu navigation and the PC. The TO 3 has an interface that allows further processing of the measured values and remote control of the device. The measured values are displayed in scientific form.

You can choose between the three fixed voltages 10 V, 100 V and 500 V or a variable measuring voltage that can be set in 1 V steps from 1 V to 500 V.

The measuring voltage has a low residual ripple and, in the event of a short circuit, a very small stored pulse energy. The continuous short-circuit current is approx. 3 mA.

I_x (Current measurement)

Measuring range: 0.01 x 10⁻¹² A resolution to 1.1 x 10⁻³ A

Display: 3½ digits (0.0 to 1.100)

Accuracy at 23 °C +/- 1 K within 12 months:
 range 1 to 5: +/- 0.3% +2 digits
 range 6: +/- 0.5% +2 digits
 range 7: +/- 1% +2 digits

Temperature coefficient:: 15 °C to 35 °C: +/-0.1% / K

Internal resistance of the circuit (R_i):

range 1: 200 Ω (auto) and 1.1 kΩ
 range 2: 10.1 kΩ
 range 3: 100 kΩ
 range 4: 1 MΩ
 range 5: 10 MΩ
 range 6: 100 MΩ
 range 7: 1 GΩ

Overvoltage protection at input R_x / I_x: +/- 10 VDC

Overcurrent protection at input R_x / I_x: +/- 10 mADC

High-Ohm (High resistance measurement)

Measuring range:

at test voltage
 1 V: 0.9 x 10³ to 3.3 x 10¹² Ω
 10 V: 9 x 10³ to 33 x 10¹² Ω
 100 V: 90 x 10³ to 0.33 x 10¹⁵ Ω
 500 V: 450 x 10³ to 1.6 x 10¹⁵ Ω
 to 2 x 10¹⁵ detectable

Accuracy at 23 °C +/- 1 K within 12 months:

range 1 to 5: +/- 0.3% +2 digits
 range 6: +/- 0.5% +2 digits
 range 7: +/- 1% +2 digits

Temperature coefficient:: 15 °C to 35 °C: +/-0.1% / K

Test voltage: 10 V, 100 V, 500 V or variable 1 V bis 500 V

Accuracy of test voltage: at 23 °C: +/- 0.2 %

Temperature coefficient of test voltage: +/- 0.01 % / K

Temperature coefficient of test voltage: +/- 0.01 % / K

Test voltage source: permanently short-circuit proof

Overvoltage protection at:

V_M 10 V: 20 VDC
 V_M 100 V: 200 VDC
 V_M 500 V: 750 VDC

var. V_M 1 V to 500 V: 2 x V_M, max. 750 VDC

Test Voltage V_M OFF: EUT discharge over 10 kΩ (the contact V_M is connected to GND through a 10 kΩ resistor)

Overvoltage at V_M OFF: +/- 100 VDC

R_x / I_x connectors: coax jack 4 mm/13 mm (DIN 47284)

V_M / GND: panel jack 4 mm

Special version: Tera-Ohmmeter TO 3 cable

For measurements on test objects earthed on one side or using a mains-independent reference potential, e.g. To determine the volume resistance of installed floor coverings or for measurements in a water bath, the special version of the TO 3 ohmmeter, the TO 3 cable, is available.

High ohm electrode FE 50

Application with high-ohm electrode FE 50

High-ohm measuring electrode for resistance measurement of volumes and on surfaces according to DIN IEC 62631, ISO 21178 and others

Measurement of surface resistivity

The surface resistance of the measuring area is calculated according to Ohm's law from the quotient of the applied voltage and the e.g. after 1 minute current flowing between electrodes 1 and 2 (see circuit diagram below).

The surface resistivity of a specimen made of solid, electrically insulating material must be calculated taking into account the geometric shape of the ring electrode used (electrode factor). For the ring electrode FE 50, an electrode factor of 34.56 results based on the characteristic measuring area.

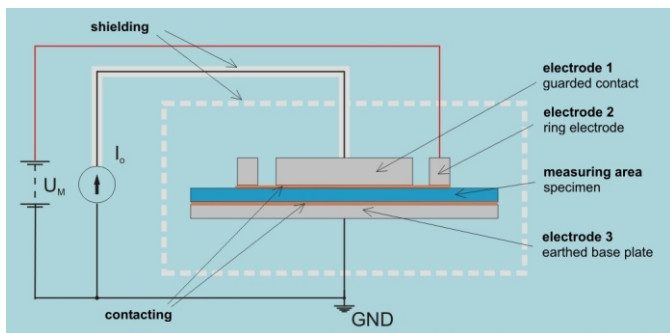

Basic circuit for protected electrodes for measuring the surface resistivity using the example of the ring electrode FE 50

The TO 3 and Milli-TO 3 terahmmeters automatically calculate the specific resistance after entering the electrode factor and selecting the appropriate menu. The calculated specific resistance value is displayed in scientific form.

Technical data FE 50:

Stainless steel version (V2A)

Diameter measuring area:	50 mm
Diameter guard ring:	80 mm outside 60 mm inside
Resulting measuring gap:	5 mm
Measuring gap with adapter-volume ring:	1 mm
effective measuring area with volume resistance measurement:	20,43 cm ²
Maximum test voltage:	500 V
Recommended measuring range:	10 ⁵ to 10 ¹⁵ Ohm



Measurement of surface resistance with base plate GP 14 and Milli-TO 3

Measurement of volume resistivity

The volume resistance of the sample material is calculated according to Ohm's law, from the quotient of the applied voltage and the current flowing between electrodes 1 and 3 (see circuit diagram below).

The volume resistivity of a sample made of solid, electrically insulating material must be calculated taking into account the geometric shape of the ring electrode used (electrode factor) and the sample thickness. The electrode factor characteristic of the geometry of the ring electrode is the quotient of the effective area of the protected electrode and the average thickness of the material sample.

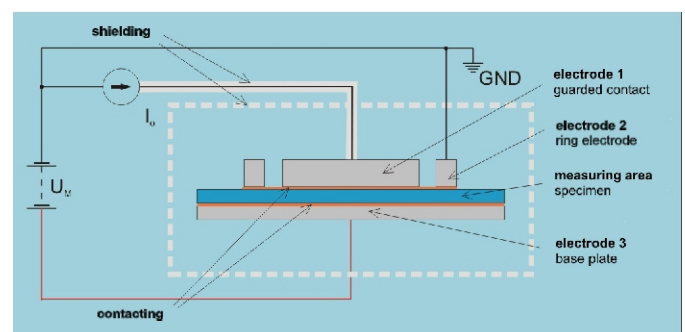

Basic circuit for protected electrodes for measuring the volume resistivity using the ring electrode FE 50

High-ohm calibration box KB-FE50

for checking the high-ohm guard ring electrode FE 50 in connection with additional calibrated standard resistors



KB-FE50 with FE 50 (optional) and calibration resistor (optional)

- ▶ calibration box for easy check/calibration the high ohm guard ring electrode FE 50
- ▶ precise positioning and connecting of the electrode
- ▶ universally applicable through connecting with our calibration resistors
- ▶ 4 mm connecting sockets
- ▶ switchable for measuring surface and volume resistance
- ▶ easy connection to Milli-TO 3 and TO 3
- ▶ maximum test voltage: 500 V
- ▶ different versions and adapters for other electrodes

The calibration box KB-FE50 was specially developed for quick and easy checking of the FE 50 high-ohm guard ring electrode.

In connection with our TeraOhmmeters Milli-TO 3 / TO-3 and our optional high-ohm calibration resistors, precisely reproducible measurements are possible to check the entire measurement setup.

The high-ohm calibration box is available in various designs and with various adapters for other measuring electrodes.

optional High-ohm calibration resistors:

Type	Value *	Calibration tolerance
N3	1 E 3 Ω (1 kΩ)	0,1 % at 1 test voltage
N4	1 E 4 Ω (10 kΩ)	0,1 % at 10 Volt test voltage
N5	1 E 5 Ω (100 kΩ)	0,1 % at 100 Volt test voltage
N6	1 E 6 Ω (1 MΩ)	0,1 % at 100 Volt test voltage
N7	1 E 7 Ω (10 MΩ)	0,3 % at 100 Volt test voltage
N8	1 E 8 Ω (100 MΩ)	0,5 % at 100 Volt test voltage
N9	1 E 9 Ω (1 GΩ)	0,5 % at 100 Volt test voltage
N10	1 E 10 Ω (10 GΩ)	0,5 % at 100 Volt test voltage
N11	1 E 11 Ω (100 GΩ)	currently not available
N12	1 E 12 Ω (1 TΩ)	currently not available

* nominal value tolerance +0 to -10 %



KB-FE50 with Adapter ring and plate* for guard ring electrode FE25*, (*optional)

Optional accessories:

- High-ohm calibration resistors
- High-ohm guard ring electrode FE 50 / FE 25
- TeraOhmmeter Milli-TO 3 / TO 3
- Adapter set for electrodes FE 25, FE 25-1 and others
- Special version for hand-held electrode HOW 1



KB-FE50 with FE 50*, calibration resistor and Milli-TO 3* (*optional)

Calibration resistors

For checking and calibration of ohmmeters

High-ohm calibration resistors 10^3 to 10^{12} Ω

Type	Value *	Calibration tolerance
N3	1 E 3 Ω (1 k Ω)	0.1 % measured at 1 Volt
N4	1 E 4 Ω (10 k Ω)	0.1 % measured at 10 Volt
N5	1 E 5 Ω (100 k Ω)	0.1 % measured at 100 Volt
N6	1 E 6 Ω (1 M Ω)	0.1 % measured at 100 Volt
N7	1 E 7 Ω (10 M Ω)	0.3 % measured at 100 Volt
N8	1 E 8 Ω (100 M Ω)	0.5 % measured at 100 Volt
N9	1 E 9 Ω (1 G Ω)	0.5 % measured at 100 Volt
N10	1 E 10 Ω (10 G Ω)	0.5 % measured at 100 Volt
N11	1 E 11 Ω (100 G Ω)	currently not available
N12	1 E 12 Ω (1 T Ω)	currently not available

* Tolerance +0 bis -10 % from the nominal value

- **Optional accessories:**
- High-ohm calibration box for quick and easy checking and calibration of high-ohm measuring electrodes
 - Special version for our cable ohmmeters

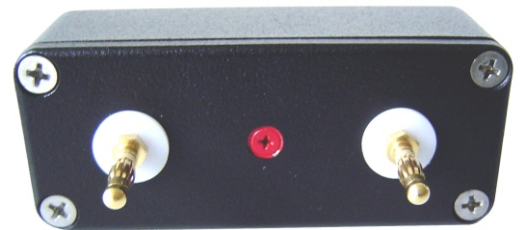

For direct connection to Milli-TO 3 and TO 3 (also available with 4 mm connection sockets)

Low-ohm calibration resistors 10^{-2} Ω to 10^3 Ω (4-pole)

Type	Value	Calibration tolerance
N001N	0.01 Ω	0,1 % measured at 1 A test current
N01N	0.1 Ω	0,1 % measured at 1 A test current
N0N	1 Ω	0,1 % measured at 0.1 A test current
N1N	10 Ω	0,1 % measured at 0.01 A test current
N2N	100 Ω	0,1 % measured at 1mA test current
N3N	1 k Ω	0,1 % measured at 0.1 mA test current
N4N	10 k Ω	0,1 % measured at 0.01mA test current
N5N	100 k Ω	0,1 % measured at 0.001 mA test current

- Factory certificate standard (DAkkS-Calibration on request)
- further resistance values and special designs on request

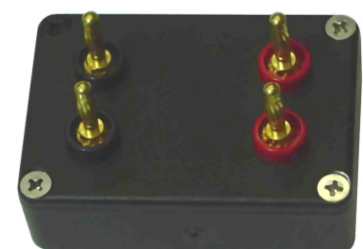

For direct connection to Milli-TO 3 and MO 3 (also available with 4 mm connection sockets)

Type FE 50: 20 cm²; measuring gap 1/5/10 mm
 Type FE 25: 5 cm²; measuring gap 1/5/6,5 mm
 Type 3604 FE: 4.6 cm²; measuring gap 1 mm
 Type 3605 FE: 19.2 cm²; measuring gap 1 mm
 Type 3607 FE: 20 cm²; measuring gap 5 mm

Guard ring electrode
FE 25



Leak electrode
AE 30-DIN/ANSI

Guard ring electrodes

according DIN, EN, IEC, ASTM e.g.

for measuring surface and volume resistances

- stainless steel (V2A)
- max. test voltage 500 V
- measuring range: 10³ bis 10¹⁵ Ω

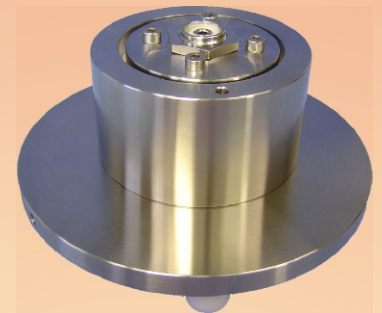

Guard ring electrode
FE 50 with base plate GP 14

Electrodes for small samples

- ring electrodes for surface and volume resistance measurements on small plate-shaped samples according DIN
- Measurement of color samples and other coatings

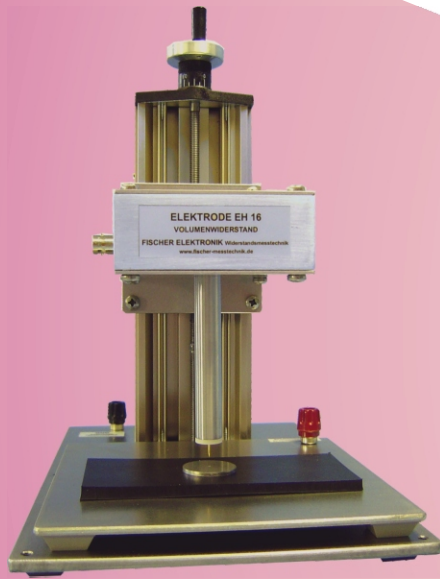

EH 16

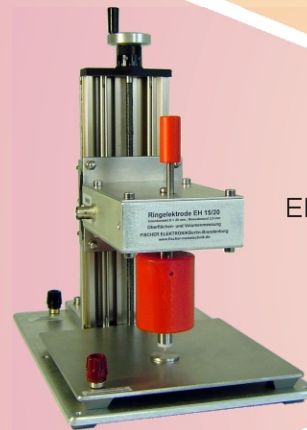

EH 15/20



Floor electrode
FBE 1

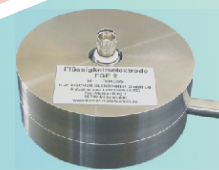

Liquid electrode
FSE 2



Liquid electrode
FSE 3



Floor electrode
FBE 4



Conveyor belt electrode
FGE 1



Textile strip electrode
TSE 1

Special electrodes

- for various applications
- specially developed and coordinated

Spring tongues electrode

- for measuring the surface resistance of foils according to DIN EN 62631-3-2
- fine and precise contact strips at a distance of 10 mm, measuring length 100 mm
- measuring range 10^5 bis $10^{12} \Omega$, max. 500 V test voltage

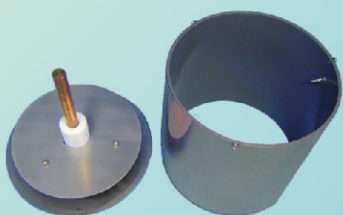
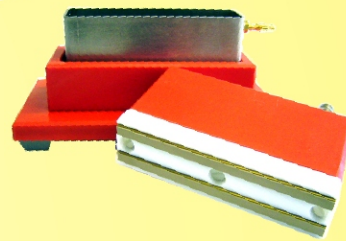
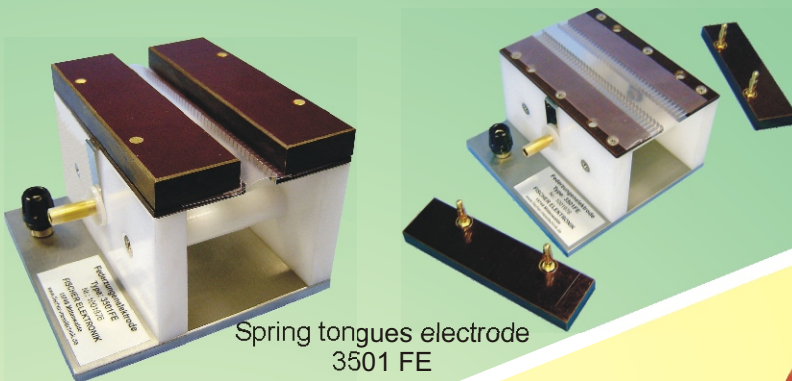

Type HOW 1: measuring area 100 x 10 mm
 Type HOW 3: measuring area 50 x 5 mm
 Type HOW 16: measuring area 16.5 cm²; with spring contacts for Curved surfaces

Hand-held electrodes
 - for measuring surface resistance according DIN, EN und IEC
 - optimized for the measurement on surfaces of objects, on painted test panels or pads



We develop according to your Wishes and Requirements your special Electrode.

Please contact us!

Low-ohm electrodes and accessories

Kelvin clamps:

- Type KEZ Micro: for very thin wires and the finest contact points
- Type KEZ Mini: for contact points 0.5 mm - 5 mm
- Type KEZ Standard RE: for contact points 1 mm - 15 mm
- Type KEZ Max: for contact points 5 mm - 15 mm
- Type KEZ 60: for contact points 10 mm - 60 mm
- Type KEZ clamp: maximum opening width 150 mm

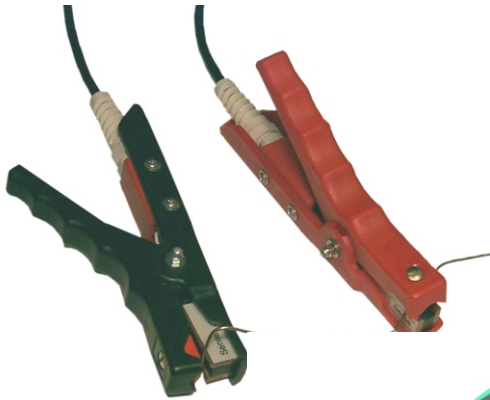

Kelvin-Spikes:

- Type KSP 2:
- Four-pole measurement spikes

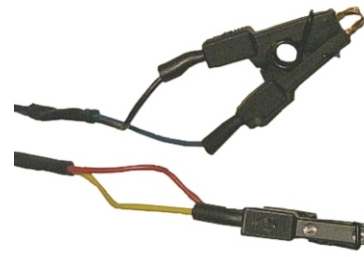

Four-pole electrodes:

- Type 4P-1: Four-pole electrode according DIN EN ISO 3915

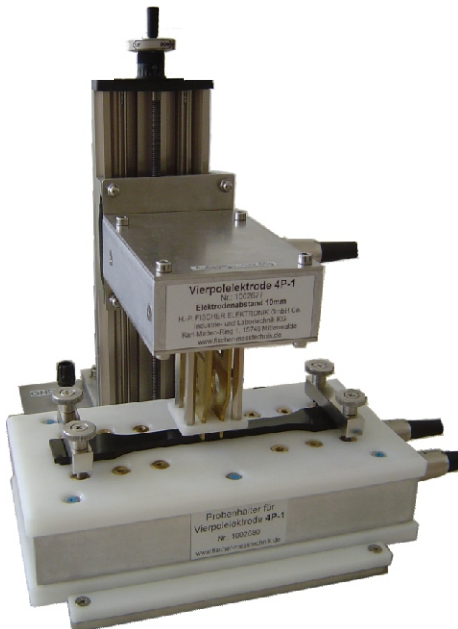

- Type VE-D991: Four-pole electrode According ASTM D 991

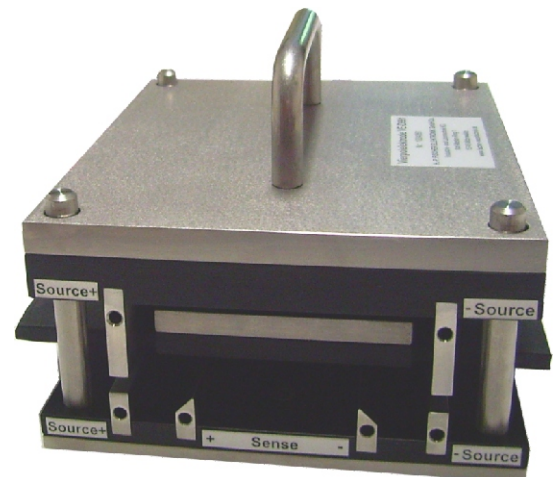

High-ohm shield chamber TOM 300-2

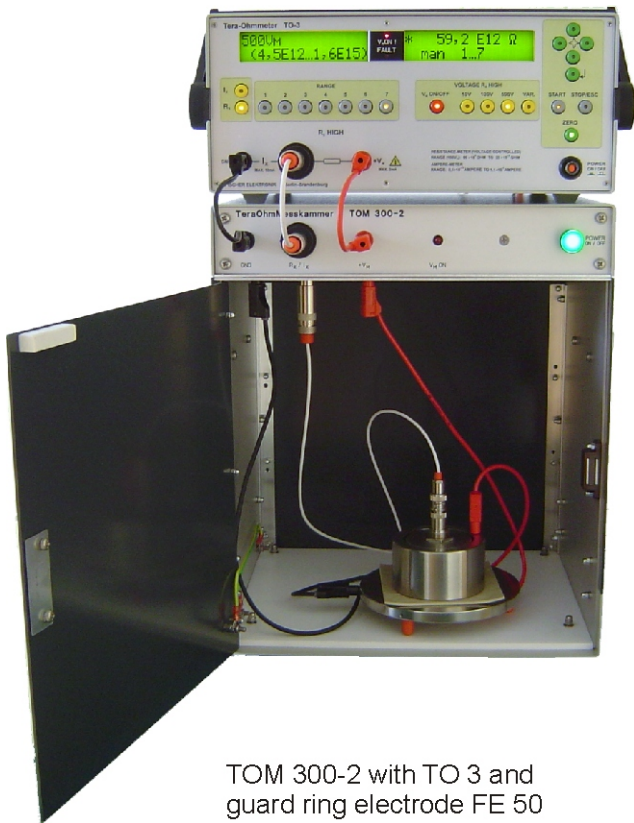

TOM 300-2 with TO 3 and guard ring electrode FE 50

Application

The TOM 300-2 measuring chamber is used to shield external influences when measuring high surface or volume resistances with a Tera-Ohmmeter.

In connection with our TeraOhmmeters Milli-TO 3 and TO 3, precise measurements in the high-ohm range can be carried out reproducibly.

The structural design and the large measuring area of approx. 300 mm x 300 mm x 250 mm allow for quick assembly and control of the measuring arrangement.

The high-ohm measuring input of the shielding chamber TOM 300-2 is equipped with a protective circuit that enables the test object to be discharged.

Dimensions (W/H/D):	310 mm x 370 mm x 265 mm
Shielded volume:	300 x 300 x 250 mm ³
Operating voltage:	power supply 230 VAC /12 VDC
Maximum test voltage:	500 V
Recommend measuring range:	1 x 10 ³ to 1 x 10 ¹⁵ Ω
Connectors:	DIN 4/13 and 4 mm sockets
Gewicht:	7.0 kg

Small high-ohm shield chamber TOM 5

Application

The small TOM 5 measuring chamber is used to shield external influences when measuring high surface or volume resistances with a Tera-Ohmmeter.

In conjunction with the measuring devices Milli-TO 3 and TO 3, precise measurements in the high-resistance range can be carried out reproducibly.

The structural design allows fast measurements to be carried out using standard alligator clips or customer-specific contacts.

To check the ambient temperature of the test object, a temperature sensor can be inserted into the closed measuring chamber through the opening on the cover.

Thin PTFE wires can also be carried for additional control.

TOM 5 with alligator clip



Dimensions:	145 mm x 95 mm x 90 mm
Shielded volume:	140 x 90 x 40 mm ³
Maximum contact distance:	depending on the design of the test object up to approx. 140 mm
Maximum test voltage:	500 V
Recommend measuring range:	1 x 10 ³ to 1 x 10 ¹⁵ Ω
Connectors:	DIN 4/13 and 4 mm sockets

Tracking index test apparatus CTI 4

For determination of proof (PTI) and the comparative (CTI) tracking indices of solid insulating materials according to the standards DIN EN 60112 (VDE 0303-11), IEC 60112

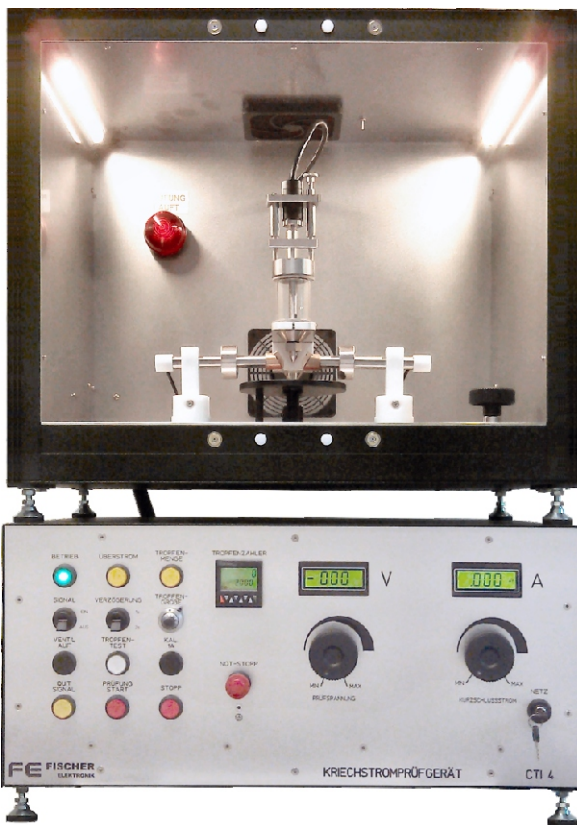

Technical data:

Dimension (W/H/D):	control unit:	610 mm x 305 mm x 600 mm
	test unit:	610 mm x 550 mm x 450 mm
Weight	control unit:	approx. 35 kg
	Test unit	approx. 30 kg
Operation voltage:	230 V	
Test voltage:	0 to 600 VAC	

Accessories:

- Platinum electrodes
- Seal kit for dropper

CTI - Comparative Tracking Index

numerical value of the maximum voltage in volts at which five test specimens withstand the test period for 50 drops without tracking failure and without a persistent flame occurring and including also a statement relating to the behaviour of the material when tested using 100 drops. No tracking failure and no persistent flame is allowed at any lower test voltage.

PTI - Proof Tracking Index

Numerical value of the proof voltage in volts at which five test specimens withstand the test period for 50 drops without tracking failure and without a persistent flame occurring

The tracking resistance is determined with the CTI value (Comparative Tracking Index) and checked with the PTI value (Proof Tracking Index).

The CTI value indicates the voltage up to which the base material shows no tracking (base material becomes conductive under voltage) when 50 drops of a standardized electrolyte solution are dropped on. Measurements are taken on the surface of the test specimen, with a drop falling between two platinum electrodes every 30 seconds.

The structure of the functions enables the most precise tests to be carried out through fine adjustment options for the test voltage, current limitation, switch-off time, drop size and number of drops.

The test voltage is adjustable up to 600 V.

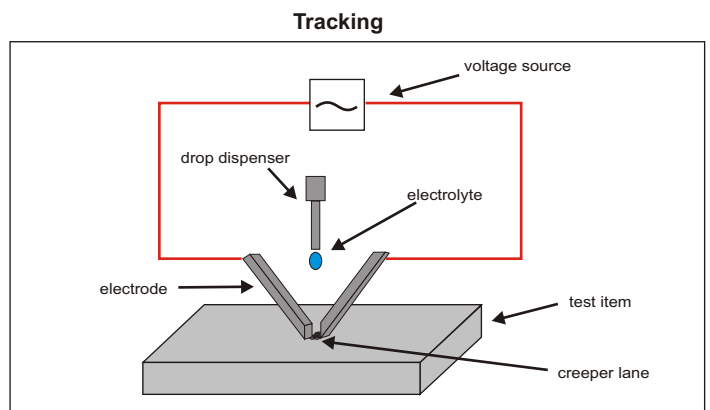

- ▶ test device for determining the relative resistance of solid insulating materials against tracking
- ▶ test according DIN EN 60112, IEC 60112
- ▶ determination (CTI / PTI)
- ▶ setting of test voltage, current limitation, switch-off time, drop size and number of drops
- ▶ r.m.s display of current and voltage
- ▶ drop interval 30 sec

Material testing equipment

Glow-wire test apparatus GPG 3 and GPG 2.3

for determining ignitability and flammability of materials, finished products and components using glow wire according DIN EN 60695-2-10;2014 and IEC 60695-2-10;2013

GPG 3



- ▶ test unit to detect the Glow Wire Flammability Index (GWFI), der Glow Wire Ignition Temperature(GWIT) and the Glow Wire Temperature (GWT)
- ▶ test according to DIN EN 60695-2-10;2014 and IEC 60695-2-10;2013
- ▶ adjustment of glow wire temperature from 100 °C bis 999 °C
- ▶ processor-controlled test procedure
- ▶ automatic positioning of the specimen trolley
- ▶ automatic limitation of the test period
- ▶ electronic analysis of the penetration depth
- ▶ r.m.s. indication of the heater current
- ▶ pressing force 1 N
- ▶ scale for flame height

Technical data:

Dimension (W/H/D): 570 mm x 550 mm x 340 mm
Weight: approx. 27 kg
Operation weight: 230 V

Accessories:

Glow wire loop with hole for thermocouple Ø 1 mm
Thermocouple type K Ø 1 mm
Silver foil 20 cm, wooden board, tissue paper
Quick change sample holder (optional)

GPG 2.3

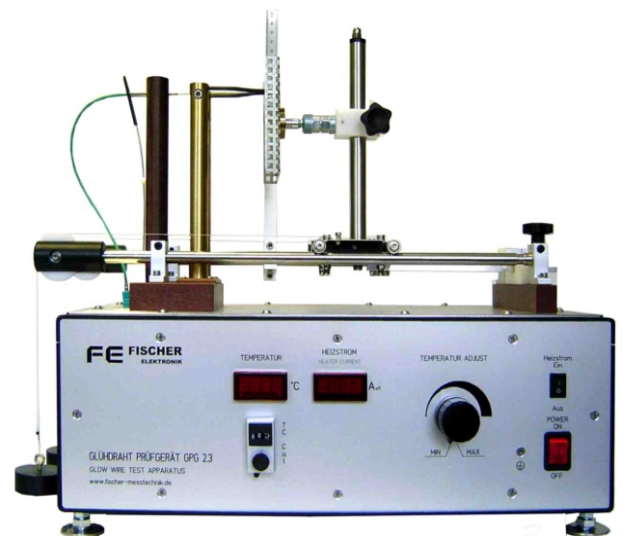

- ▶ test unit to detect the Glow Wire Flammability Index (GWFI), der Glow Wire Ignition Temperature(GWIT) and the Glow Wire Temperature (GWT)
- ▶ test according to DIN EN 60695-2-10;2014 and IEC 60695-2-10;2013
- ▶ adjustment of glow wire temperature from 50 °C bis 999 °C
- ▶ r.m.s. indication of the heater current
- ▶ pressing force 1 N
- ▶ scale for flame height
- ▶ display for temperature and heater current

Technical data:

Dimension (W/H/D): 570 mm x 550 mm x 340 mm
Weight: approx. 27 kg
Operation weight: 230 V

The company

The H.-P. FISCHER ELEKTRONIK GmbH & Co. Industrie- und Labortechnik KG, based in Mittenwalde near Berlin, has been a medium-sized company in the field of measurement and testing technology for over 40 years.

In the specialty of resistance measurement technology, we are leaders in the field of high and low resistance measurement. FISCHER ELEKTRONIK measuring and testing devices have been tried and tested many times, especially in materials and material research, material development, but also in quality assurance and in the area of production.

A wide range of measuring devices, test equipment and measuring aids shows our experience and our know-how in solving simple and demanding measuring tasks.

Main applications are

- Resistance measurement in the high-ohm and low-ohm range
- Measuring electrodes for various material and application requirements according to the applicable DIN, EN, IEC and ASTM standards as well as customer-specific solutions
- Tests to determine the flammability (GWFI), flammability (GWIT) and glow wire temperature (GWT) of materials, end products, assemblies (glow wire test) according to standard DIN EN 60695-2
- Tests for determination of the proof (PTI) and the comparative (CTI) tracking indices of solid insulating materials according to standard DIN EN 60112

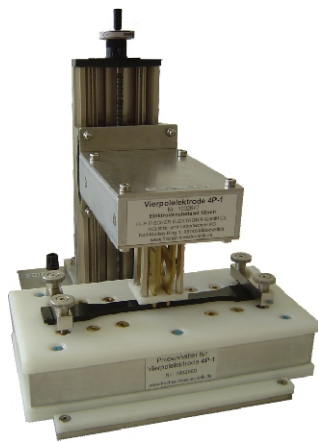
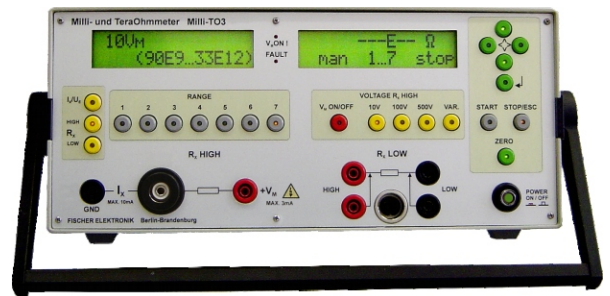

The Milli-TO series combines many years of experience with modern and exact measurement methods for precise and reproducible measurement results.

The associated spectrum of electrodes includes variants for a wide variety of applications, developed in accordance with the applicable standards of DIN, EN, IEC, ASTM and other industry and customer regulations.

Our strengths are the analysis and preparation of your measurement task. We not only manufacture standards-compliant devices, we also develop customer-specific solutions for you. We offer you an optimal service based on a closed chain of product idea, development and construction, over the prototype construction and production up to the commissioning and support on site as well as the maintenance of the devices. Our service leads you to a reliable, customized and inexpensive solution.

We see demanding problems as a welcome challenge. On request, we develop tailor-made products and solutions that take into account and meet your individual requirements and framework conditions.

Areas of application for resistance measurement to determine material properties and parameters include in research and development of new materials, production and quality assurance as well as quality control.

The spectrum is wide; Examples include the plastics industry, the manufacture of cables and wires, the manufacture of floor coverings or varnishes, but also the pharmaceutical or textile industries and the automotive industry in various fields of application.

Challenge us and entrust us with your measurement task. We advise you, qualified and individually, by telephone or on site. Use our know-how and experience.

We are happy to help you. Please do not hesitate to contact us!

